

The logo for NOVA, featuring the word "NOVA" in a bold, sans-serif font. The letter "O" is stylized with a vertical line through it, and the letters "V" and "A" have a small red and blue triangle above them respectively. The background of the entire page is a black and white architectural sketch of an office interior, showing a desk, chair, and storage units. On the left side, there is a vertical decorative border composed of a grid of colorful diamond shapes in shades of red, blue, and green.

**NOVA**

# OFFICE SOLUTIONS



**"DESIGN IS NOT JUST WHAT IT LOOKS  
LIKE AND FEELS LIKE. DESIGN IS HOW  
IT WORKS."**





# ROYAL







EXECUTIVE FURNITURE

Royal Model

Desk with Cabinet Extension

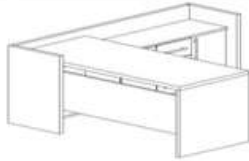

Dimension	Code
180 X 90 X 73cm	Royal 180 L/R
200 X 90 X 73cm	Royal 200 L/R
220 X 90 X 73cm	Royal 220 L/R

Cabinet Details

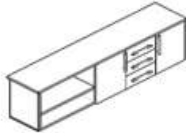

200 X 56 X 80cm

Mobile Pedestal

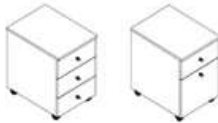

Two Drawer

58 X 43 X 55cm

FP 2

Three Drawer

58 X 43 X 55cm

FP 3

Coffee Table

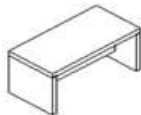

Small Coffee Table

50 X 50 X 45cm MCS 5

Larg Coffee Table

100 X 50 X 45cm MCL 10



Small Coffee Table

50 X 50 X 45cm RCS 5

Larg Coffee Table

100 X 50 X 45cm RCL 10

Meeting Table



Rectangle Table

180 X 120 X 73cm MMT 18

200 X 120 X 73cm MMT 20



Square Table

90 X 90 X 73cm MMS 9

120 X 120 X 73cm MMS 12

Available Finishes Colors

Technical List

# PLANA





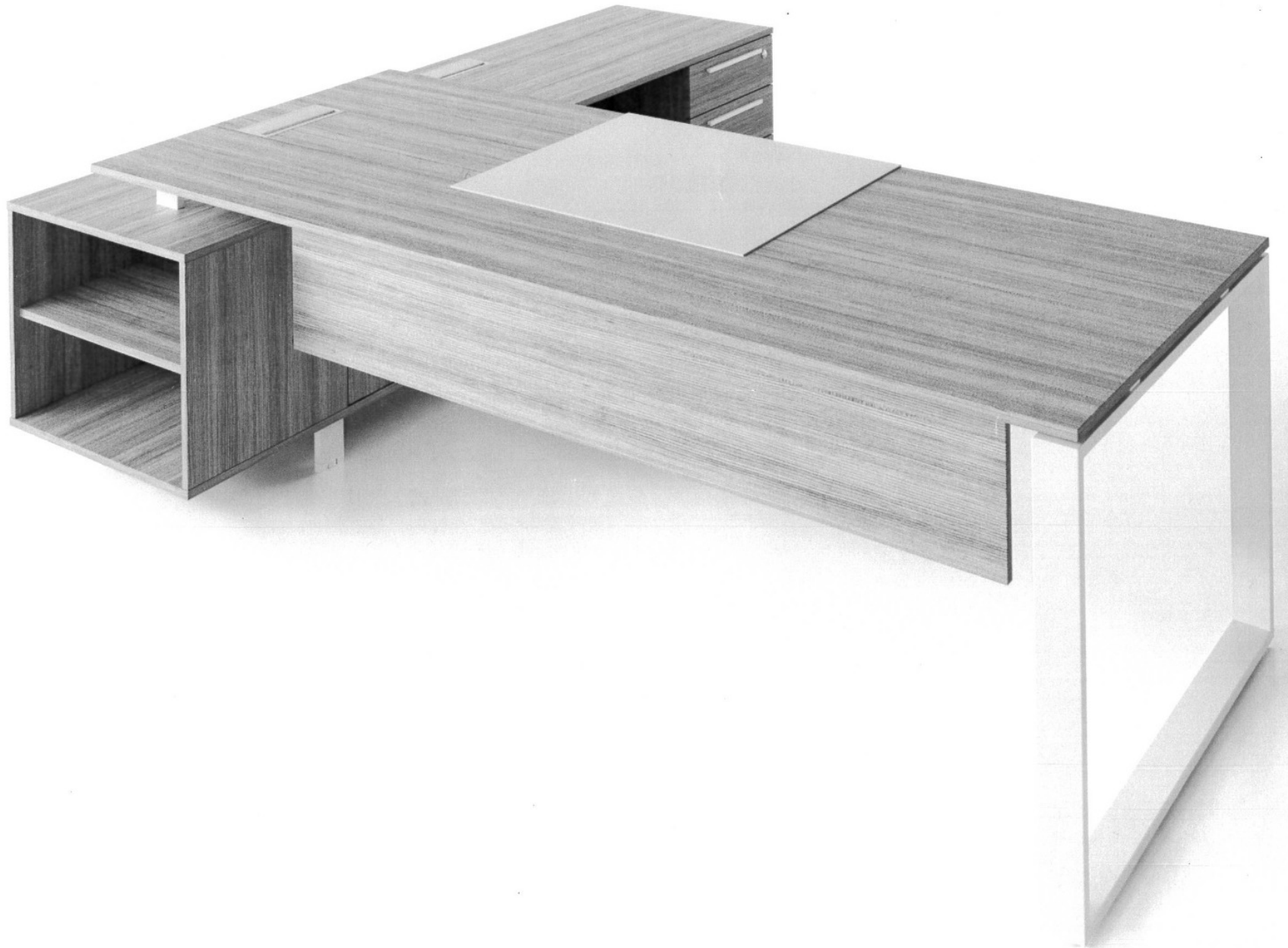





# Middle Management Desk

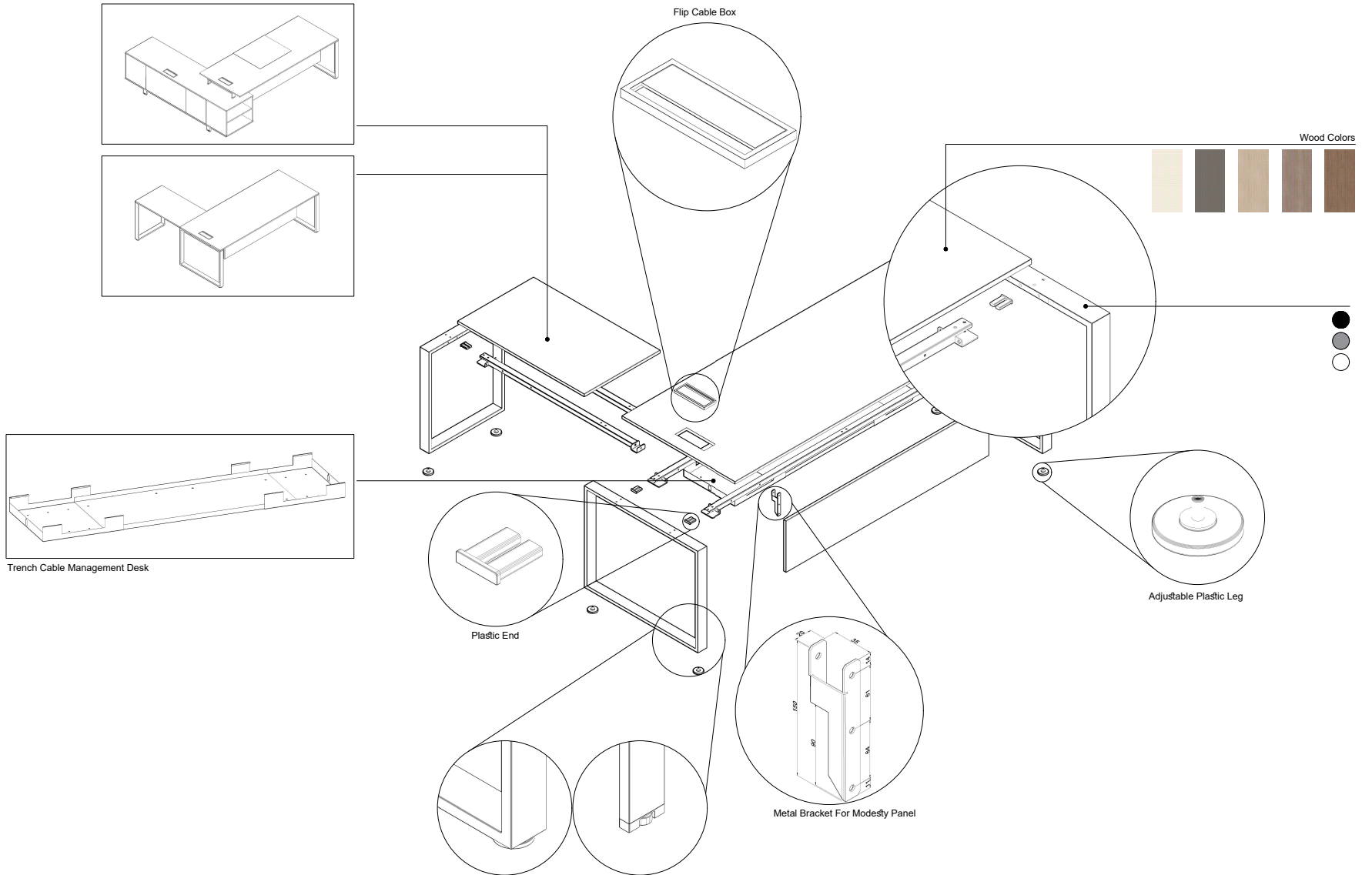

## Middle management

Pos.	Descriptions	Legs type 8X2		Metal Finish / Color		Wood Color / Finish				
		Loop	legs	White	Gray	white	Gray	Ontario	133 BW	A401
<b>Middle Management Desk</b>										
A	Single peninsula desk L220 X W90 X H75	○	●	○	○	○	○	○	○	○
B	Single desk L140 X W90 X H73	○	●	○	○	○	○	○	○	○
C	Single desk L160 X W90 X H73	○	●	○	○	○	○	○	○	○
D	Single desk L180 X W90 X H73	○	●	○	○	○	○	○	○	○
<b>Middle Management Extension ( Platform ) Supporting unit</b>										
A	Peninsula Extension desk W225 X D60 X H60.5		●	○	○	○	○	○	○	○
B	Extension desk - Fixed W100 X D60 X H73	○	●	○	○	○	○	○	○	○
C	Extension desk - Fixed W120 X D60 X H73	○	●	○	○	○	○	○	○	○
D	Extension desk - Mobile W100 X D60 X H73	○	●	○	○	○	○	○	○	○
E	Extension desk - Mobile W120 X D60 X H73	○	●	○	○	○	○	○	○	○
<b>Middle Management Modesty panel</b>										
A	Modesty panel for Single peninsula desk L220	●	●	●	●	○	○	○	○	○
B	Modesty panel for Single desk for desk L140	●	●	●	●	○	○	○	○	○
C	Modesty panel for Single desk for desk L160	●	●	●	●	○	○	○	○	○
D	Modesty panel for Single desk for desk L180	●	●	●	●	○	○	○	○	○
<b>Middle Management Coffee Table</b>										
A	Small table W60 X D60 X H40	○	●	○	○	○	○	○	○	○
B	Large table W100 X D60 X H40	○	●	○	○	○	○	○	○	○
C	Small table W60 X D60 X H40	●	○	○	○	○	○	○	○	○
D	Large table W100 X D60 X H40	●	○	○	○	○	○	○	○	○

## Middle management

Pos.	Descriptions	Legs type 8X2		Metal Finish / Color		Wood Color / Finish				
		Loop	legs	White	Gray	white	Gray	Ontario	133 BW	A401
<b>Middle Management Meeting Tables-125</b>										
A	Meeting table L120 X W125 X H75	○	●	○	○	○	○	○	○	○
B	Meeting table L240 X W125 X H75	○	●	○	○	○	○	○	○	○
<b>Middle Management Meeting Tables-165</b>										
A	Meeting table L160 X W165 X H75	○	●	○	○	○	○	○	○	○
B	Meeting table L320 X W165 X H75	○	●	○	○	○	○	○	○	○
<b>Middle Management / Cable Management</b>										
A	Set of under-desk trays size	●	●	○	○	●	●	●	●	●
B	Set of under-desk trays size	●	●	○	○	●	●	●	●	●
C	Set of under-desk trays size	●	●	○	○	●	●	●	●	●
D	Computer stand - metal rail fixing Holder size	●	●	○	○	●	●	●	●	●
E	Top access	●	●	○	○	●	●	●	●	●

● not available

Technical Specifications

# SLIVER DESK













# T - LEG DESK





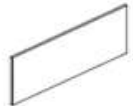
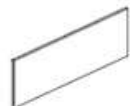

OPERATIVE FURNITURE  
Silver Model

Desk	Dimensions	Code	Desk	Dimensions	Code
	120 X 80 X 73cm	SD 12		120 X 80 X 73cm	SDT 12
	140 X 80 X 73cm	SD 14		140 X 80 X 73cm	SDT 14
	160 X 80 X 73cm	SD 16		160 X 80 X 73cm	SDT 16
	180 X 80 X 73cm	SD 18		180 X 80 X 73cm	SDT 18
	200 X 80 X 73cm	SD 20		200 X 80 X 73cm	SDT 20
<b>L-Shaped Desk</b>			<b>Fixed Side Return</b>		
	120 X 120 X 73cm 80/60	SDT 1212 L/R		80 X 50 X 73cm	SFS 8
	140 X 140 X 73cm 80/60	SDT 1414 L/R		100 X 50 X 73cm	SFS10
	160 X 160 X 73cm 80/60	SDT 1616 L/R		120 X 50 X 73cm	SFS12
	160 X 120 X 73cm 80/60	SDT 1612 L/R			
<b>Side Return</b>			<b>Fixed Side Return</b>		
	100 X 60 X 73cm	SST 10		80 X 50 X 73cm	SFC 8
	120 X 60 X 73cm	SST 12		100 X 50 X 73cm	SFC10
				120 X 50 X 73cm	SFC12
<b>Mobile Pedestal</b>			<b>Meeting Table</b>		
	58 X 43 X 55cm	FP 2		80 X 80 X 73cm	SMT 8
	59 X 43 X 55cm	FP 3		100 X 100 X 73cm	SMT 10
				120 X 100 X 73cm	SMT 12
				140 X 100 X 73cm	SMT 14
				180 X 100 X 73cm	SMT 18
			200 X 100 X 73cm	SMT 20	
<b>Coffee Table</b>					
	50 X 50 X 45cm	SCS 5			
<b>Modesty panel</b>			<b>Screen</b>		
	100 X 40cm	SM 10		80 X 45cm	SC 8
	120 X 40cm	SM 12		100 X 45cm	SC 10
	140 X 40cm	SM 14		120 X 45cm	SC 12
	160 X 40cm	SM 16		140 X 45cm	SC 14
	180 X 40cm	SM 18		160 X 45cm	SC 16
			180 X 45cm	SC 18	
			200 X 45cm	SC 20	

Technical List

# e.t-leg desk





# TECHNICAL DATA

GENERAL CONTROL BOX	
<b>Power supply</b>	120 VAC ±10% / 60 Hz
<b>Standby power consumption, primarily</b>	<0.3 W
<b>Operating temperature</b>	0-35°C
<b>Protection class</b>	IP 20
<b>Maximum power output</b>	216VA/24V

  

TWO-COLUMN FRAME WITH CONTROL BOX	
<b>Maximum lift capacity</b>	200 lb (= 90 kg / 890N)
<b>Adj. range, depending on version</b>	View Illustration B
<b>Maximum input current</b>	5 A
<b>Maximum duty cycle</b>	10% (2 min. on / 18 min. off)

THREE-COLUMN FRAME WITH CONTROL BOX	
<b>Maximum lift capacity</b>	250 lb (= 113 kg / 1112N)
<b>Adj. range, depending on version</b>	View Illustration B
<b>Maximum input current</b>	6.5 A
<b>Maximum duty cycle</b>	10% (2 min. on / 18 min. off)

ILLUSTRATION B

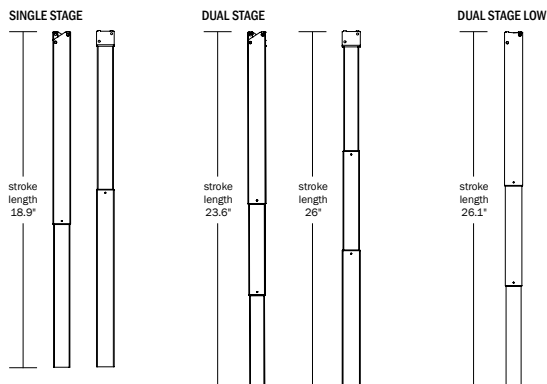

# Free Stand Desks



## Operative Desks With Structural Elements

Pos.	Descriptions	Legs type 8X2		Metal Finish / Color		Wood Color / Finish				
		Loop	legs	White	Gray	white	Gray	Ontario	133 BW	A401
<b>Desk With Pedestals / SUPPORT D80</b>										
	Single peninsula desk L120 X D80 X H73	●	○	○	○	○	○	○	○	○
	Single peninsula desk L140 X D80 X H73	●	○	○	○	○	○	○	○	○
	Single peninsula desk L160 X D80 X H73	●	○	○	○	○	○	○	○	○
	Single peninsula desk L180 X D80 X H73	●	○	○	○	○	○	○	○	○
<b>Desk With Pedestals / SUPPORT D60</b>										
	Single peninsula desk L120 X D60 X H73	●	○	○	○	○	○	○	○	○
	Single peninsula desk L140 X D60 X H73	●	○	○	○	○	○	○	○	○
	Single peninsula desk L160 X D60 X H73	●	○	○	○	○	○	○	○	○
	Single peninsula desk L180 X D60 X H73	●	○	○	○	○	○	○	○	○
<b>Pedestals for desk / SUPPORT D80</b>										
	Pedestals for Single peninsula desk L120	●	○	○	○	○	○	○	○	○
	Pedestals for Single peninsula desk L140	●	○	○	○	○	○	○	○	○
	Pedestals for Single peninsula desk L160	●	○	○	○	○	○	○	○	○
	Pedestals for Single peninsula desk L180	●	○	○	○	○	○	○	○	○
<b>Pedestals for desk / SUPPORT D60</b>										
	Pedestals for Single peninsula desk L120	●	○	○	○	○	○	○	○	○
	Pedestals for Single peninsula desk L140	●	○	○	○	○	○	○	○	○
	Pedestals for Single peninsula desk L160	●	○	○	○	○	○	○	○	○
	Pedestals for Single peninsula desk L180	●	○	○	○	○	○	○	○	○
<b>Operative Desks / Cable Management</b>										
	Set of under-desk trays size L120	●	●	○	○	●	●	●	●	●
	Set of under-desk trays size L140	●	●	○	○	●	●	●	●	●
	Set of under-desk trays size L160	●	●	○	○	●	●	●	●	●
	Set of under-desk trays size L180	●	●	○	○	●	●	●	●	●
	Computer stand - metal rail fixing Holder size	●	●	○	○	●	●	●	●	●
	Top access	●	●	○	○	●	●	●	●	●

- not available

### Technical Specifications

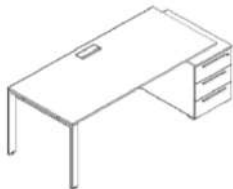

---



## Operative Desks

Pos.	Descriptions	Legs type 8X2		Metal Finish / Color		Wood Color / Finish				
		Loop	legs	White	Gray	white	Gray	Ontario	133 BW	A401
<b>Operative Desks W80</b>										
	Single desk L120 X W80 X H73	●	○	○	○	○	○	○	○	○
	Single desk L140 X W80 X H73	●	○	○	○	○	○	○	○	○
	Single desk L160 X W80 X H73	●	○	○	○	○	○	○	○	○
	Single desk L180 X W80 X H73	●	○	○	○	○	○	○	○	○
<b>Operative Desks W60</b>										
	Single desk L120 X W60 X H73	●	○	○	○	○	○	○	○	○
	Single desk L140 X W60 X H73	●	○	○	○	○	○	○	○	○
	Single desk L160 X W60 X H73	●	○	○	○	○	○	○	○	○
	Single desk L180 X W60 X H73	●	○	○	○	○	○	○	○	○
<b>Operative Desks Modesty panel</b>										
	Modesty panel for Single desk for desk L120	●	●	●	●	○	○	○	○	○
	Modesty panel for Single desk for desk L140	●	●	●	●	○	○	○	○	○
	Modesty panel for Single desk for desk L160	●	●	●	●	○	○	○	○	○
	Modesty panel for Single desk for desk L180	●	●	●	●	○	○	○	○	○
<b>Operative Desks Screen panel</b>										
	Screen panel for Single desk for desk L120	●	●	●	●	○	○	○	○	○
	Screen panel for Single desk for desk L140	●	●	●	●	○	○	○	○	○
	Screen panel for Single desk for desk L160	●	●	●	●	○	○	○	○	○
	Screen panel for Single desk for desk L180	●	●	●	●	○	○	○	○	○
<b>Operative Desks / Cable Management</b>										
	Set of under-desk trays size L120	●	●	○	○	●	●	●	●	●
	Set of under-desk trays size L140	●	●	○	○	●	●	●	●	●
	Set of under-desk trays size L160	●	●	○	○	●	●	●	●	●
	Set of under-desk trays size L180	●	●	○	○	●	●	●	●	●
	Computer stand - metal rail fixing Holder size	●	●	○	○	●	●	●	●	●
	Top access	●	●	○	○	●	●	●	●	●

- not available

### Technical Specifications





# Operative Desks With Structural Elements Pedestals & Cabinets

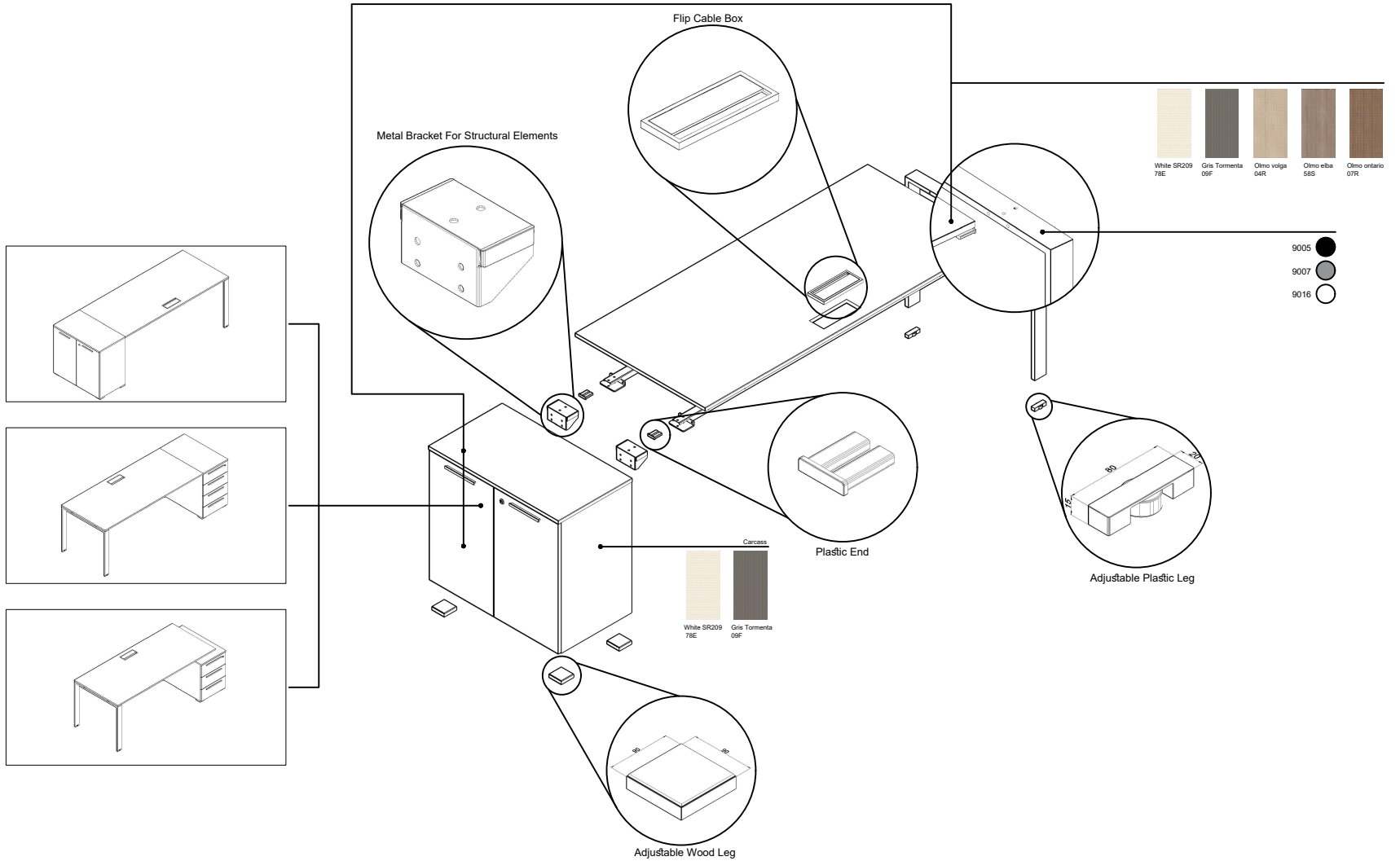

## Operative Desks With Structural Elements

Pos.	Descriptions	Legs type 8X2		Metal Finish / Color		Wood Color / Finish				
		Loop	legs	White	Gray	white	Gray	Ontario	133 BW	A401
<b>Desk With Pedestals / ATTACHED D80 ( Left or Right )</b>										
	Single peninsula desk L120 X D80 X H73	●	○	○	○	○	○	○	○	○
	Single peninsula desk L140 X D80 X H73	●	○	○	○	○	○	○	○	○
	Single peninsula desk L160 X D80 X H73	●	○	○	○	○	○	○	○	○
	Single peninsula desk L180 X D80 X H73	●	○	○	○	○	○	○	○	○
<b>Desk With Pedestals / ATTACHED D60 ( Left or Right )</b>										
	Single peninsula desk L120 X D60 X H73	●	○	○	○	○	○	○	○	○
	Single peninsula desk L140 X D60 X H73	●	○	○	○	○	○	○	○	○
	Single peninsula desk L160 X D60 X H73	●	○	○	○	○	○	○	○	○
	Single peninsula desk L180 X D60 X H73	●	○	○	○	○	○	○	○	○
<b>Pedestals for desk / ATTACHED D80 ( Left or Right )</b>										
	Pedestals for Single peninsula desk L120	●	○	○	○	○	○	○	○	○
	Pedestals for Single peninsula desk L140	●	○	○	○	○	○	○	○	○
	Pedestals for Single peninsula desk L160	●	○	○	○	○	○	○	○	○
	Pedestals for Single peninsula desk L180	●	○	○	○	○	○	○	○	○
<b>Pedestals for desk / ATTACHED D60 ( Left or Right )</b>										
	Pedestals for Single peninsula desk L120	●	○	○	○	○	○	○	○	○
	Pedestals for Single peninsula desk L140	●	○	○	○	○	○	○	○	○
	Pedestals for Single peninsula desk L160	●	○	○	○	○	○	○	○	○
	Pedestals for Single peninsula desk L180	●	○	○	○	○	○	○	○	○
<b>Operative Desks / Cable Management</b>										
	Set of under-desk trays size L120	●	●	○	○	●	●	●	●	●
	Set of under-desk trays size L140	●	●	○	○	●	●	●	●	●
	Set of under-desk trays size L160	●	●	○	○	●	●	●	●	●
	Set of under-desk trays size L180	●	●	○	○	●	●	●	●	●
	Computer stand - metal rail fixing Holder size	●	●	○	○	●	●	●	●	●
	Top access	●	●	○	○	●	●	●	●	●

● not available

### Technical Specifications

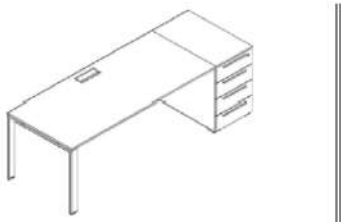

## Operative Desks With Structural Elements

Pos.	Descriptions	Legs type 8X2		Metal Finish / Color		Wood Color / Finish				
		Loop	legs	White	Gray	white	Gray	Ontario	133 BW	A401
<b>Desk With Cabinets / ATTACHED D80 ( Left or Right )</b>										
	Single peninsula desk L120 X D80 X H73	●	○	○	○	○	○	○	○	○
	Single peninsula desk L140 X D80 X H73	●	○	○	○	○	○	○	○	○
	Single peninsula desk L160 X D80 X H73	●	○	○	○	○	○	○	○	○
	Single peninsula desk L180 X D80 X H73	●	○	○	○	○	○	○	○	○
<b>Desk With Cabinets / ATTACHED D60 ( Left or Right )</b>										
	Single peninsula desk L120 X D60 X H73	●	○	○	○	○	○	○	○	○
	Single peninsula desk L140 X D60 X H73	●	○	○	○	○	○	○	○	○
	Single peninsula desk L160 X D60 X H73	●	○	○	○	○	○	○	○	○
	Single peninsula desk L180 X D60 X H73	●	○	○	○	○	○	○	○	○
<b>Cabinets for desk / ATTACHED D80 ( Left or Right )</b>										
	Pedestals for Single peninsula desk L120	●	○	○	○	○	○	○	○	○
	Pedestals for Single peninsula desk L140	●	○	○	○	○	○	○	○	○
	Pedestals for Single peninsula desk L160	●	○	○	○	○	○	○	○	○
	Pedestals for Single peninsula desk L180	●	○	○	○	○	○	○	○	○
<b>Cabinets for desk / ATTACHED D60 ( Left or Right )</b>										
	Pedestals for Single peninsula desk L120	●	○	○	○	○	○	○	○	○
	Pedestals for Single peninsula desk L140	●	○	○	○	○	○	○	○	○
	Pedestals for Single peninsula desk L160	●	○	○	○	○	○	○	○	○
	Pedestals for Single peninsula desk L180	●	○	○	○	○	○	○	○	○
<b>Operative Desks / Cable Management</b>										
	Set of under-desk trays size L120	●	●	○	○	●	●	●	●	●
	Set of under-desk trays size L140	●	●	○	○	●	●	●	●	●
	Set of under-desk trays size L160	●	●	○	○	●	●	●	●	●
	Set of under-desk trays size L180	●	●	○	○	●	●	●	●	●
	Computer stand - metal rail fixing Holder size	●	●	○	○	●	●	●	●	●
	Top access	●	●	○	○	●	●	●	●	●

● not available

### Technical Specifications

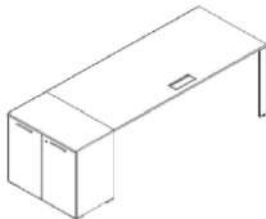

# WORK STATIONS





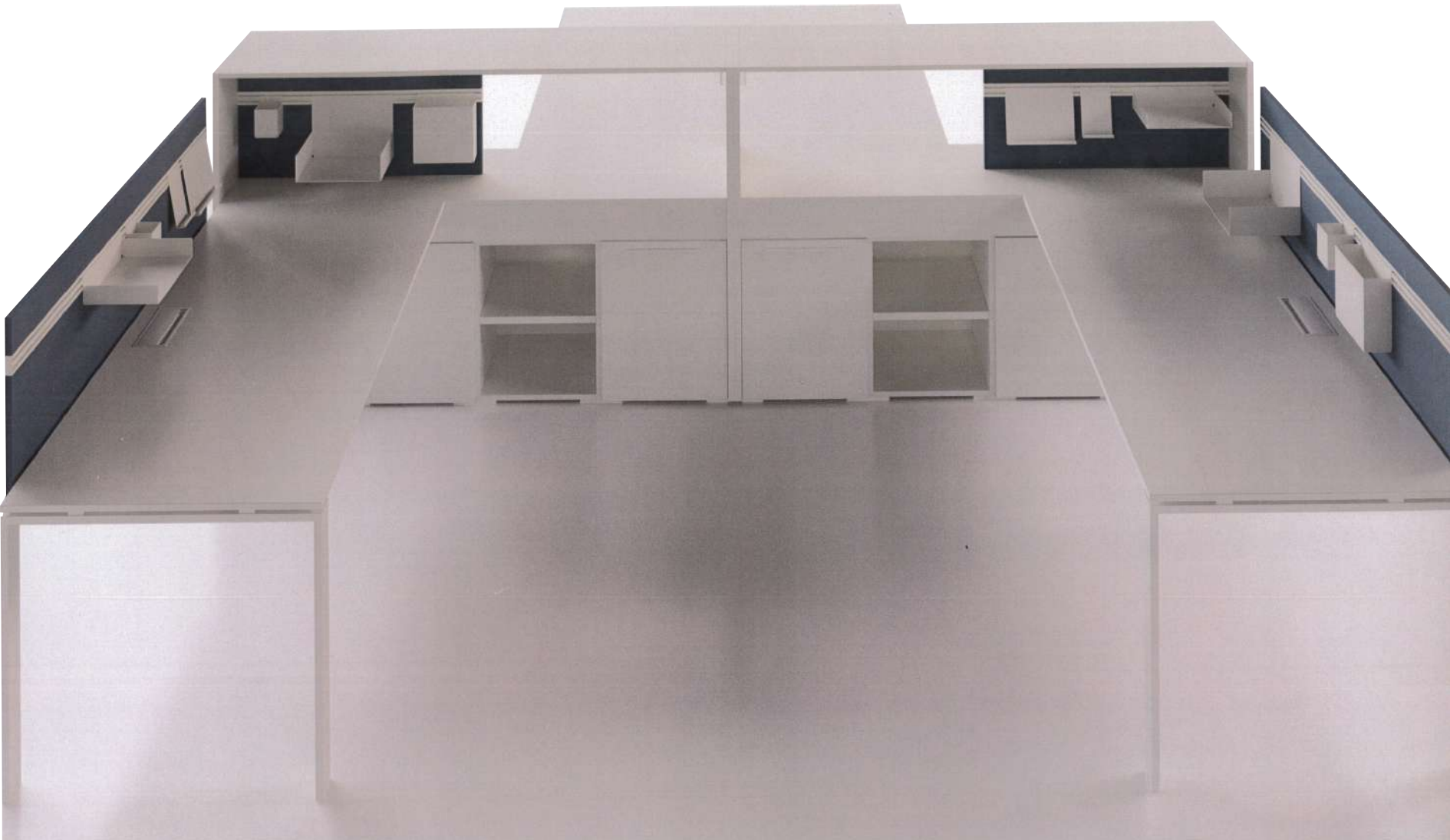

















## Operative Benches

Pos.	Descriptions	Legs type 8X2		Metal Finish / Color		Wood Color / Finish				
		Loop	legs	White	Gray	white	Gray	Ontario	133 BW	A401
<b>Workstation W125 - Double desk with wooden screen</b>										
	Double desk L120 X W125 X H73	●	○	○	○	○	○	○	○	○
	Double desk L140 X W125 X H73	●	○	○	○	○	○	○	○	○
	Double desk L160 X W125 X H73	●	○	○	○	○	○	○	○	○
	Double desk L180 X W125 X H73	●	○	○	○	○	○	○	○	○
<b>Workstation W125 - Double desk with wooden screen</b>										
	Double desk L120 X W125 X H73	○	●	○	○	○	○	○	○	○
	Double desk L140 X W125 X H73	○	●	○	○	○	○	○	○	○
	Double desk L160 X W125 X H73	○	●	○	○	○	○	○	○	○
	Double desk L180 X W125 X H73	○	●	○	○	○	○	○	○	○
<b>Workstation W165 - Double desk with wooden screen</b>										
	Double desk L120 X W165 X H73	●	○	○	○	○	○	○	○	○
	Double desk L140 X W165 X H73	●	○	○	○	○	○	○	○	○
	Double desk L160 X W165 X H73	●	○	○	○	○	○	○	○	○
	Double desk L180 X W165 X H73	●	○	○	○	○	○	○	○	○
<b>Workstation W165 - Double desk with wooden screen</b>										
	Double desk L120 X W165 X H73	○	●	○	○	○	○	○	○	○
	Double desk L140 X W165 X H73	○	●	○	○	○	○	○	○	○
	Double desk L160 X W165 X H73	○	●	○	○	○	○	○	○	○
	Double desk L180 X W165 X H73	○	●	○	○	○	○	○	○	○
<b>Workstation W125 - Multiple desk with wooden screen - Desk L120</b>										
	Multiple desk L240 X W125 X H73	●	○	○	○	○	○	○	○	○
	Multiple desk L360 X W125 X H73	●	○	○	○	○	○	○	○	○
	Multiple desk L480 X W125 X H73	●	○	○	○	○	○	○	○	○

- not available

### Technical Specifications



## Operative Benches

Pos.	Descriptions	Legs type 8X2		Metal Finish / Color		Wood Color / Finish				
		Loop	legs	White	Gray	white	Gray	Ontario	133 BW	A401
<b>Workstation W165 - Multiple desk with wooden screen - Desk L140</b>										
	Multiple desk L280 X W165 X H73	○	●	○	○	○	○	○	○	○
	Multiple desk L420 X W165 X H73	○	●	○	○	○	○	○	○	○
	Multiple desk L560 X W165 X H73	○	●	○	○	○	○	○	○	○
<b>Workstation W125 - Multiple desk with wooden screen - Desk L160</b>										
	Multiple desk L320 X W125 X H73	●	○	○	○	○	○	○	○	○
	Multiple desk L480 X W125 X H73	●	○	○	○	○	○	○	○	○
	Multiple desk L640 X W125 X H73	●	○	○	○	○	○	○	○	○
<b>Workstation W125 - Multiple desk with wooden screen - Desk L160</b>										
	Multiple desk L320 X W125 X H73	○	●	○	○	○	○	○	○	○
	Multiple desk L480 X W125 X H73	○	●	○	○	○	○	○	○	○
	Multiple desk L640 X W125 X H73	○	●	○	○	○	○	○	○	○
<b>Workstation W165 - Multiple desk with wooden screen - Desk L160</b>										
	Multiple desk L320 X W165 X H73	●	○	○	○	○	○	○	○	○
	Multiple desk L480 X W165 X H73	●	○	○	○	○	○	○	○	○
	Multiple desk L640 X W165 X H73	●	○	○	○	○	○	○	○	○
<b>Workstation W165 - Multiple desk with wooden screen - Desk L160</b>										
	Multiple desk L320 X W165 X H73	○	●	○	○	○	○	○	○	○
	Multiple desk L480 X W165 X H73	○	●	○	○	○	○	○	○	○
	Multiple desk L640 X W165 X H73	○	●	○	○	○	○	○	○	○
<b>Workstation W125 - Multiple desk with wooden screen - Desk L180</b>										
	Multiple desk L360 X W125 X H73	●	○	○	○	○	○	○	○	○
	Multiple desk L540 X W125 X H73	●	○	○	○	○	○	○	○	○
	Multiple desk L720 X W125 X H73	●	○	○	○	○	○	○	○	○

- not available

### Technical Specifications

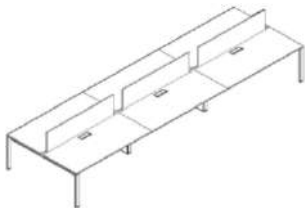

## Operative Benches

Pos.	Descriptions	Legs type 8X2		Metal Finish / Color		Wood Color / Finish				
		Loop	legs	White	Gray	white	Gray	Ontario	133 BW	A401
<b>Workstation W125 - Multiple desk with wooden screen - Desk L120</b>										
	Multiple desk L240 X W125 X H73	○	●	○	○	○	○	○	○	○
	Multiple desk L360 X W125 X H73	○	●	○	○	○	○	○	○	○
	Multiple desk L480 X W125 X H73	○	●	○	○	○	○	○	○	○
<b>Workstation W165 - Multiple desk with wooden screen - Desk L120</b>										
	Multiple desk L240 X W165 X H73	●	○	○	○	○	○	○	○	○
	Multiple desk L360 X W165 X H73	●	○	○	○	○	○	○	○	○
	Multiple desk L480 X W165 X H73	●	○	○	○	○	○	○	○	○
<b>Workstation W165 - Multiple desk with wooden screen - Desk L120</b>										
	Multiple desk L240 X W165 X H73	○	●	○	○	○	○	○	○	○
	Multiple desk L360 X W165 X H73	○	●	○	○	○	○	○	○	○
	Multiple desk L480 X W165 X H73	○	●	○	○	○	○	○	○	○
<b>Workstation W125 - Multiple desk with wooden screen - Desk L140</b>										
	Multiple desk L280 X W125 X H73	●	○	○	○	○	○	○	○	○
	Multiple desk L420 X W125 X H73	●	○	○	○	○	○	○	○	○
	Multiple desk L560 X W125 X H73	●	○	○	○	○	○	○	○	○
<b>Workstation W125 - Multiple desk with wooden screen - Desk L140</b>										
	Multiple desk L280 X W125 X H73	○	●	○	○	○	○	○	○	○
	Multiple desk L420 X W125 X H73	○	●	○	○	○	○	○	○	○
	Multiple desk L560 X W125 X H73	○	●	○	○	○	○	○	○	○
<b>Workstation W165 - Multiple desk with wooden screen - Desk L140</b>										
	Multiple desk L280 X W165 X H73	●	○	○	○	○	○	○	○	○
	Multiple desk L420 X W165 X H73	●	○	○	○	○	○	○	○	○
	Multiple desk L560 X W165 X H73	●	○	○	○	○	○	○	○	○

- not available

### Technical Specifications

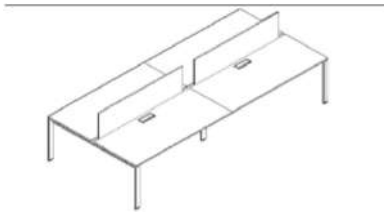



## Operative Benches

Pos.	Descriptions	Legs type 8X2		Metal Finish / Color		Wood Color / Finish				
		Loop	legs	White	Gray	white	Gray	Ontario	133 BW	A401
<b>Workstation W125 - Multiple desk with wooden screen - Desk L180</b>										
	Multiple desk L360 X W125 X H73	○	●	○	○	○	○	○	○	○
	Multiple desk L540 X W125 X H73	○	●	○	○	○	○	○	○	○
	Multiple desk L720 X W125 X H73	○	●	○	○	○	○	○	○	○
<b>Workstation W165 - Multiple desk with wooden screen - Desk L180</b>										
	Multiple desk L360 X W165 X H73	●	○	○	○	○	○	○	○	○
	Multiple desk L540 X W165 X H73	●	○	○	○	○	○	○	○	○
	Multiple desk L720 X W165 X H73	●	○	○	○	○	○	○	○	○
<b>Workstation W165 - Multiple desk with wooden screen - Desk L180</b>										
	Multiple desk L360 X W165 X H73	○	●	○	○	○	○	○	○	○
	Multiple desk L540 X W165 X H73	○	●	○	○	○	○	○	○	○
	Multiple desk L720 X W165 X H73	○	●	○	○	○	○	○	○	○
<b>Pedestals for desk / ATTACHED W125</b>										
	Pedestals for Multiple desk - 4 Drawers	●	○	○	○	○	○	○	○	○
<b>Pedestals for desk / ATTACHED W165</b>										
	Pedestals for Multiple desk - 4 Drawers	●	○	○	○	○	○	○	○	○
<b>Operative Benches / Cable Management</b>										
	Set of under-desk trays size L120	●	●	○	○	●	●	●	●	●
	Set of under-desk trays size L140	●	●	○	○	●	●	●	●	●
	Set of under-desk trays size L160	●	●	○	○	●	●	●	●	●
	Set of under-desk trays size L180	●	●	○	○	●	●	●	●	●
	Computer stand - metal rail fixing Holder size	●	●	○	○	●	●	●	●	●
	Top access	●	●	○	○	●	●	●	●	●

- not available

### Technical Specifications

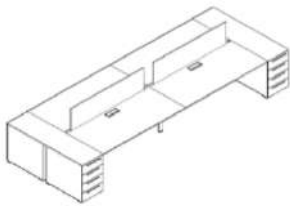

# Meeting Table













# Filing Cabinets





## Cabinets

Pos.	Descriptions	Legs type 8X2		Carcass / Color		Wood Color / Finish - door top				
		Loop	legs	White	Gray	white	Gray	Ontario	133 BW	A401
	Carcass size W90 X D45 X H80	●	●	○	○	○	○	○	○	○
	Carcass size W90 X D45 X H120	●	●	○	○	○	○	○	○	○
	Carcass size W90 X D45 X H160	●	●	○	○	○	○	○	○	○
	Carcass size W90 X D45 X H200	●	●	○	○	○	○	○	○	○
	Carcass size W45 X D45 X H80	●	●	○	○	○	○	○	○	○
	Carcass size W45 X D45 X H120	●	●	○	○	○	○	○	○	○
	Carcass size W45 X D45 X H160	●	●	○	○	○	○	○	○	○
	Carcass size W45 X D45 X H200	●	●	○	○	○	○	○	○	○
	Wood swing door W45 X H80	●	●	○	○	○	○	○	○	○
	Wood swing door W45 X H120	●	●	○	○	○	○	○	○	○
	Wood swing door W45 X H160	●	●	○	○	○	○	○	○	○
	Wood swing door W45 X H200	●	●	○	○	○	○	○	○	○
	Glass swing door W45 X H80	●	●	○	○	○	○	○	○	○
	Glass swing door W45 X H120	●	●	○	○	○	○	○	○	○
	Glass swing door W45 X H160	●	●	○	○	○	○	○	○	○
	Glass swing door W45 X H200	●	●	○	○	○	○	○	○	○
	top for cabinet	●	●	○	○	○	○	○	○	○
	side for cabinet - left	●	●	○	○	○	○	○	○	○
	side for cabinet - right	●	●	○	○	○	○	○	○	○
	Shelf	●	●	○	○	○	○	○	○	○
	Lock	●	●	●	○	●	●	●	●	●













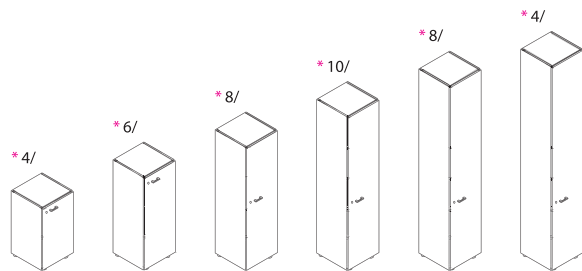

L 45  
 P 46,3  
 H1 81,5 / H2 119,8 / H3 158,3 / H4 196,7 / H5 235 / H6 260

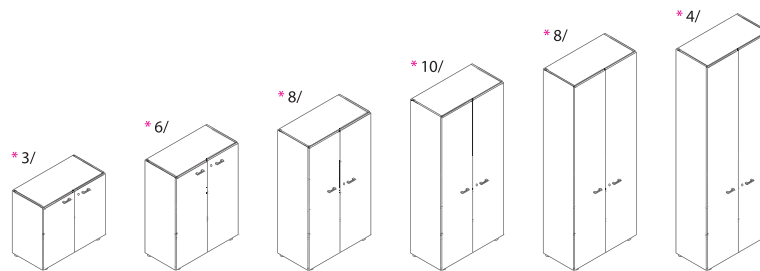

L 90  
 P 46,3  
 H1 81,5 / H2 119,8 / H3 158,3 / H4 196,7 / H5 235 / H6 260

Lockers  
 Lockers | Lockers

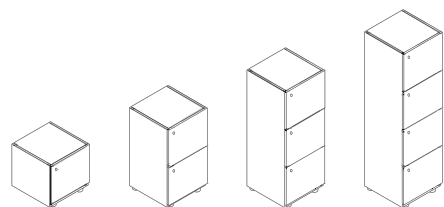

L 45  
 P 44,5



# Coffee Tables





# Coffee Tables

